

MOUNTING PLATES

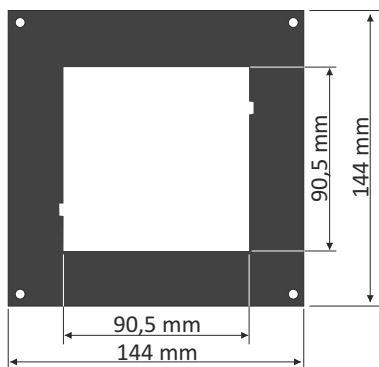

SMP-1414/99
to mount 96 x 96 mm
size unit in place
of 144 x 144 mm cut-out

DIN RAIL BRACKETS



SRH-99
TS-35 DIN rail brackets
for 96 x 96 mm case



SRH-141
TS-35 DIN rail brackets
for 144 x 144 mm case

SECURITY DOOR WITH LOCK



STD-99
transparent IP 54 door
with lock for 96 x 96 mm case

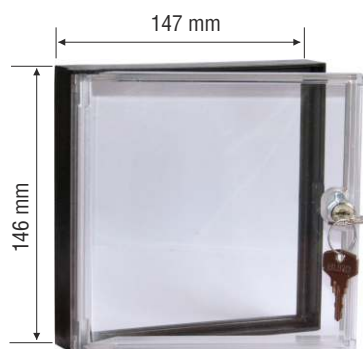

STD-141
transparent IP 54 door
with lock for 144 x 144 mm case

Transparent door with moulded frame acc. to DIN 43700, lockable with security key. Door and frame are made by injection moulding thus assuring an exact fit, an optimal choice of a material which is very strong and with no risk of corrosion; perfect seal-protective system IP 54 provided by all-round soft rubber sealing the moulding; door does not swing in or out sideways on opening; door-frame and frontframe can be exchanged.



MOUNTING BRACKETS



SPH-07
1 ÷ 7 mm board thickness
brackets (2 pcs)
standard included with device



SPH-05
1 ÷ 5 mm board thickness
brackets (2 pcs)



SPH-45
1 ÷ 45 mm board thickness
brackets (2 pcs)

USB MEMORY

MF-8

The mini USB memory stick is incredibly small and stylish flash drive offering **8GB** data storage. Measuring merely 20,6 x 15,5 x 7,0 mm (weight only 3 g), the mini USB drive is ideal for transporting data and fits inside optional lockable door STD-99/141.



PORTABLE CASE

Portable case P130

Portable transporting case, made by PELI, with input connectors for mounting **CMC-99**, **CMC-141** or **SRD-99** data recorders. It is useful in applications where there is no possibility of a typical controller / recorder safe installation. Case is very durable, has IP 65 protection class. On the side of the case there are multipin connectors for sensors and interfaces, according to customer needs.



MULTIPRINT MLP-149



MultiPrint MLP-149 for cooperation with **MultiCon** line devices.

Thermal panel printer, giving possibility to communicate with external devices using USB interface. Printer has possibility to print on thermal paper and self-adhesive labels. The user has the possibility of generating print-outs of the current measurements directly where the recorder is installed.

print media:	thermal paper and self-adhesive labels
paper width:	standardowa 57 mm
communication interface:	mini USB
print resolution:	204 DPI



LICENCE KEYS FOR MULTICON LINE

Licence Key to activate recording functions on the Data Logger

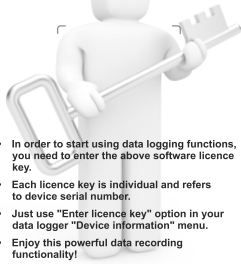

- In order to start using data logging functions, you need to enter the above software licence key.
- Each licence key is individual and refers to device serial number.
- Just use "Enter licence key" option in your data logger "Device information" menu.
- Enjoy this powerful data recording functionality!

LKS-99/141

Data logging licence key for MultiCon line

LKT-99/141

Data logging licence key for MultiCon line - 30 days trial version

Licence Key to activate e-mail notifications on the Data Logger

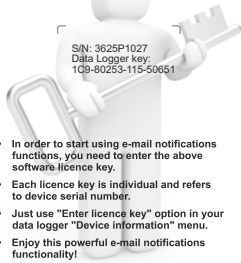

- In order to start using e-mail notifications functions, you need to enter the above software licence key.
- Each licence key is individual and refers to device serial number.
- Just use "Enter licence key" option in your data logger "Device information" menu.
- Enjoy this powerful e-mail notifications functionality!

ENS-99/141

E-mail notifications licence key for MultiCon line

ENT-99/141

E-mail notifications licence key for MultiCon line - 30 days trial version

Licence Key to activate MultiLevel Access on the Data Logger

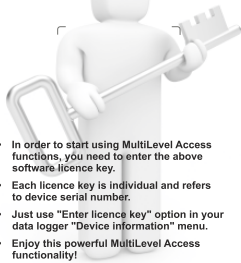

- In order to start using MultiLevel Access functions, you need to enter the above software licence key.
- Each licence key is individual and refers to device serial number.
- Just use "Enter licence key" option in your data logger "Device information" menu.
- Enjoy this powerful MultiLevel Access functionality!

MLS-99/141

MultiLevel Access licence key for MultiCon line (USB dongle option only)

MLT-99/141

MultiLevel Access licence key for MultiCon line (USB dongle option only)
- 30 days trial version

Licence Key to activate SCADALite functions on the Data Logger

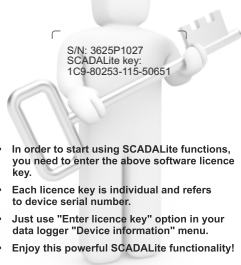

- In order to start using SCADALite functions, you need to enter the above software licence key.
- Each licence key is individual and refers to device serial number.
- Just use "Enter licence key" option in your data logger "Device information" menu.
- Enjoy this powerful SCADALite functionality!

SLS-99/141

SCADALite licence key for MultiCon line

SLT-99/141

SCADALite licence key for MultiCon line - 30 days trial version



MULTICON SOFTWARE

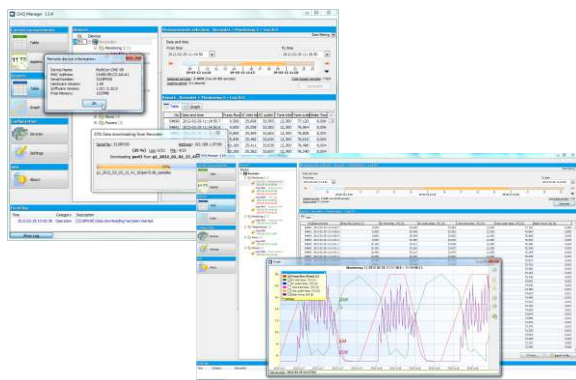

DAQ Manager

Software for managing the recorded data. The software allows to visualize data in the form of graphs and tables, group measurement results, create reports and export data into other files. Its fully functional and free of charge version can be downloaded from our website (www.multicon24.eu) or ordered as a payable CD-ROM version.



www.MultiCon24.eu

MULTILOG SOFTWARE

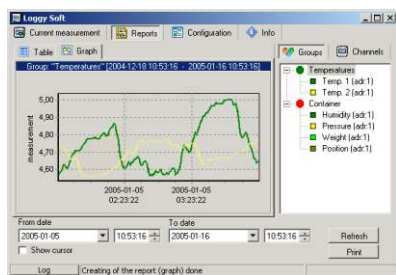

Loggy Soft

Used for service of MultiLog line data loggers. It enables the visualization, archiving and printing of measurements (e.g. temperature, humidity, pressure) stored in MultiLog devices memory. Work with MultiLog devices takes place through an RS-485 serial interface or flash-disk devices plugged into USB port. Connecting a network of units to a serial port (RS-232) or USB port of a PC is possible thanks to a converter (RS-485 to RS-232 or RS-485 to USB) produced by SIMEX.

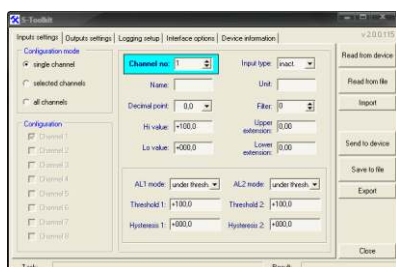

S-Toolkit

Used for service of MultiLog line data loggers. It enables configuration reading and writing operations, updating the device firmware and obtaining basic information on devices through RS-485 serial interface or flash-disk devices plugged into USB port. This application enables to quickly and easily define device parameters in one of three possible configuration models. The set of parameters can be transmitted directly to the device or stored in a file for future use.

ADDITIONAL ACCESSORIES



SRS-U4

Converter is designed to connect a USB host to slave devices equipped with RS-485 interface. The PC with special software can be used as a host. The **SRS-U4** unit guarantees full galvanic isolation between USB and RS-485 circuits. The converter can work with any devices equipped with RS-485 interface and contains integrated circuit which supports USB 1.1 and USB 2.0 standards. The main purpose is connection of PC host computer with industrial data acquisition and visualisation systems based on RS-485 interface. The **SRS-U4** can be also manufactured with DIN mounting adaptor.



SCL-N16

Case lock for N16 wall mounted cases.